

les ciseaux

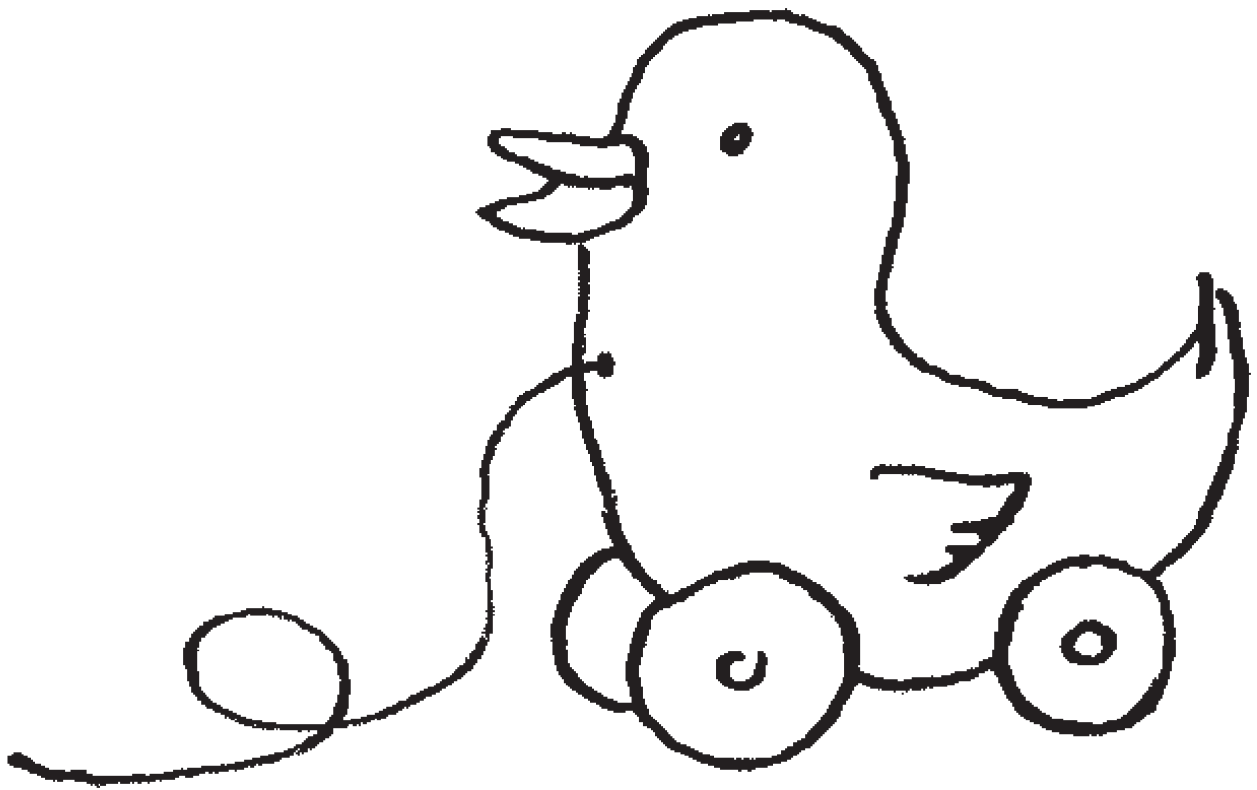

le jouet

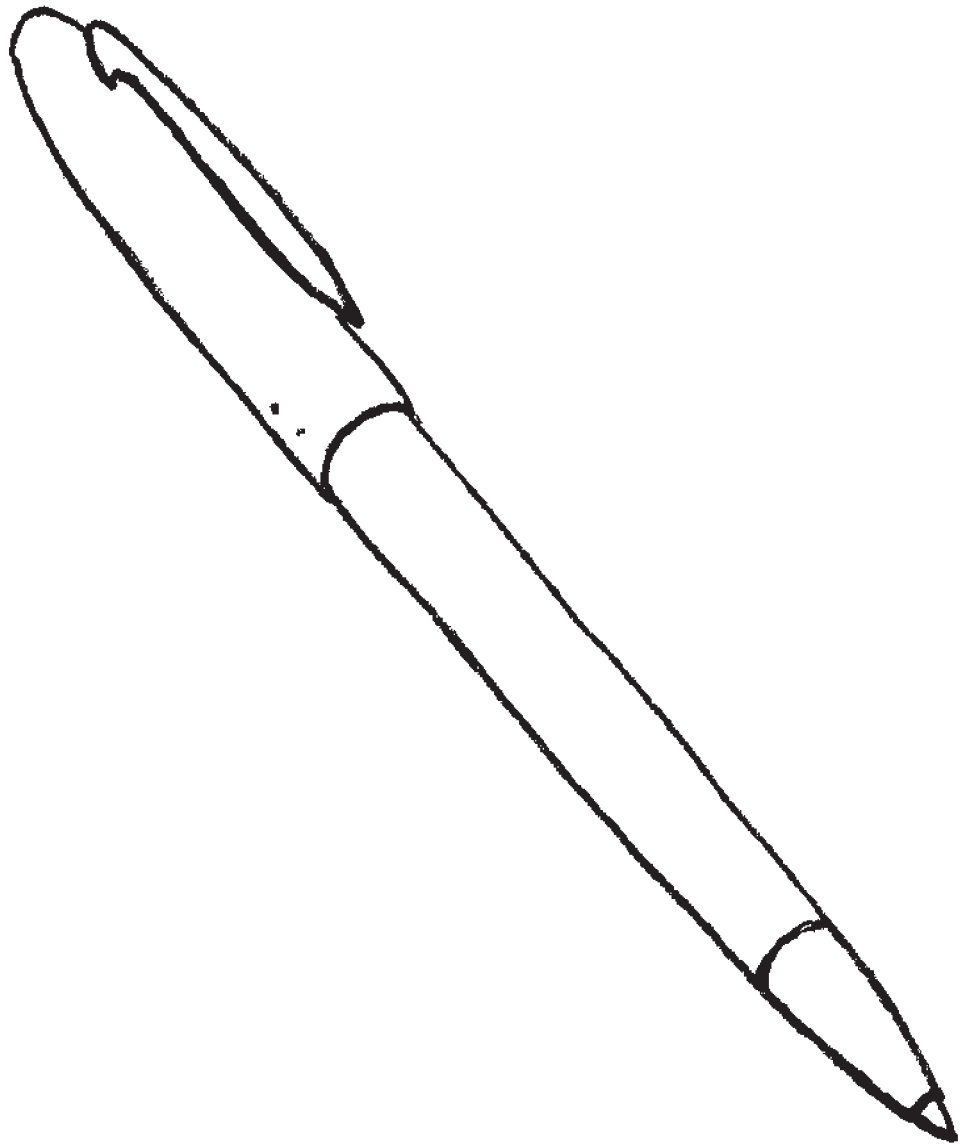

le stylo

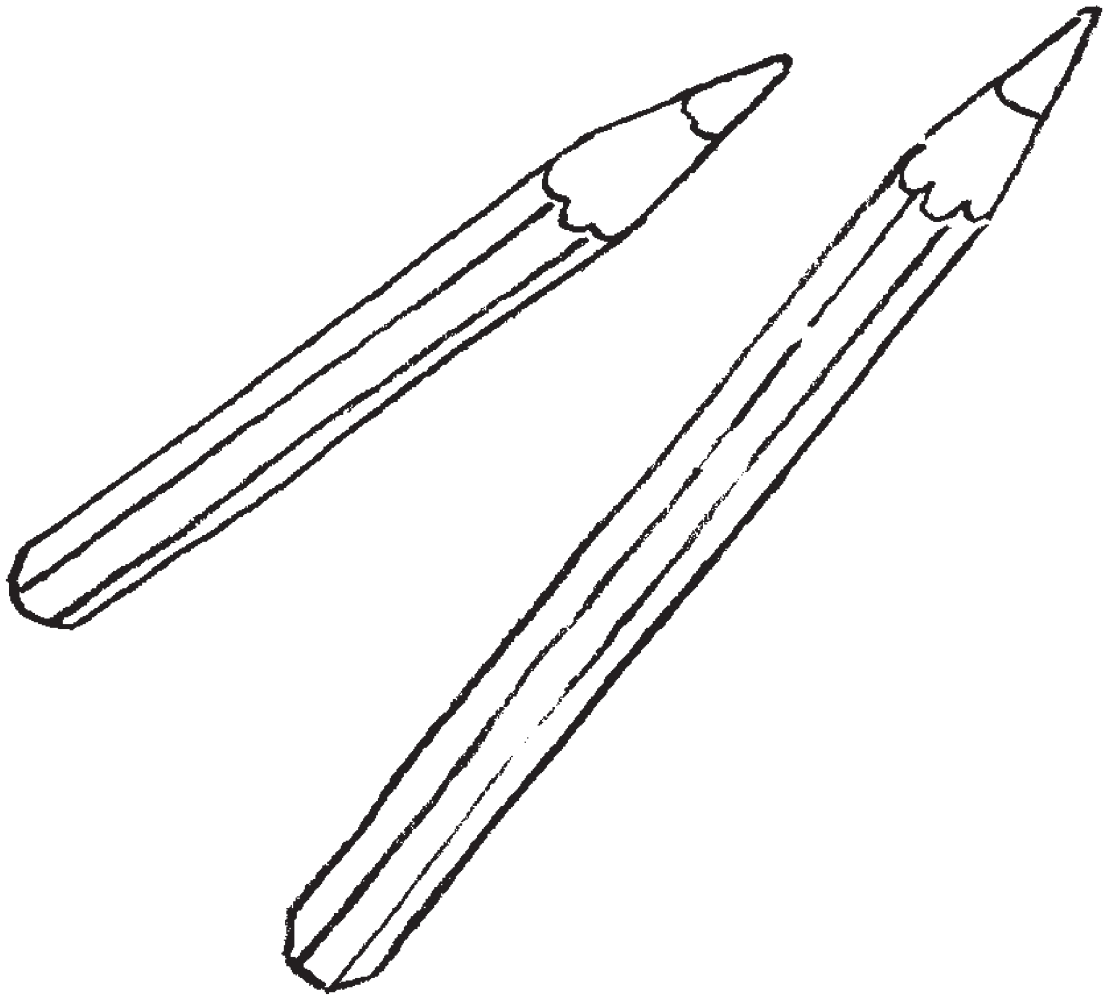

les crayons



le livre

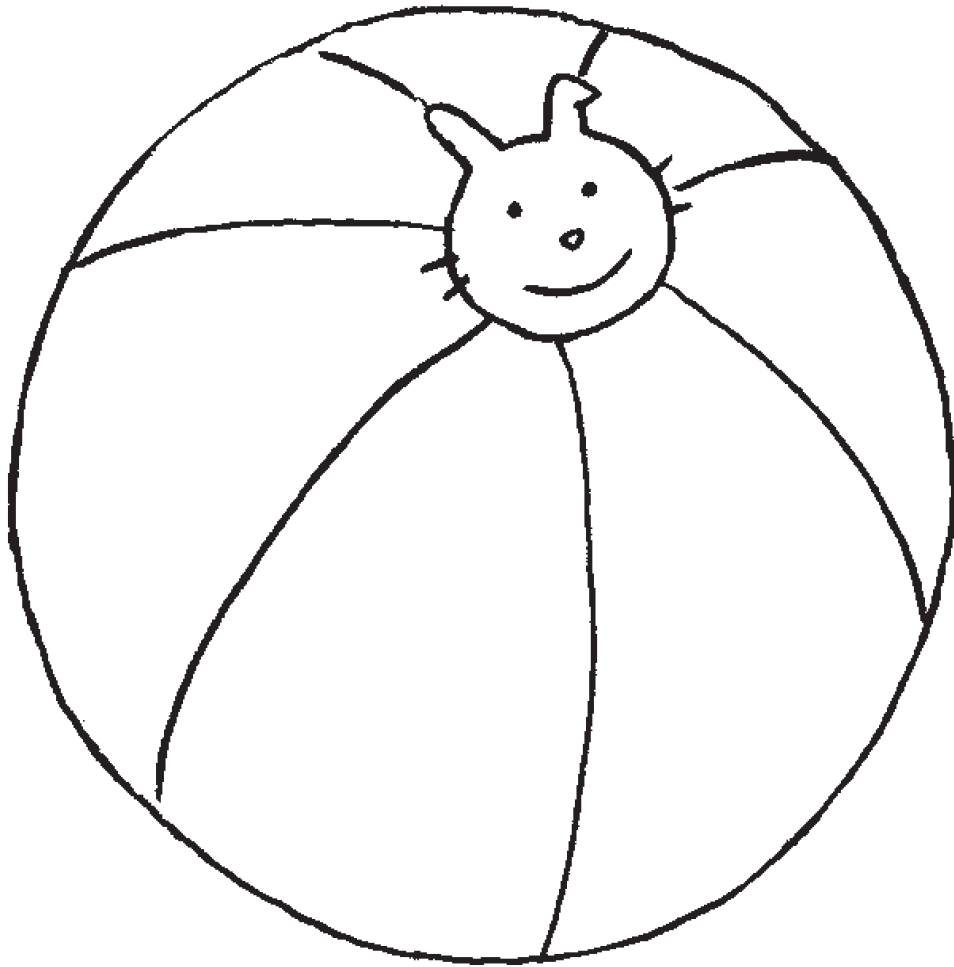

le ballon

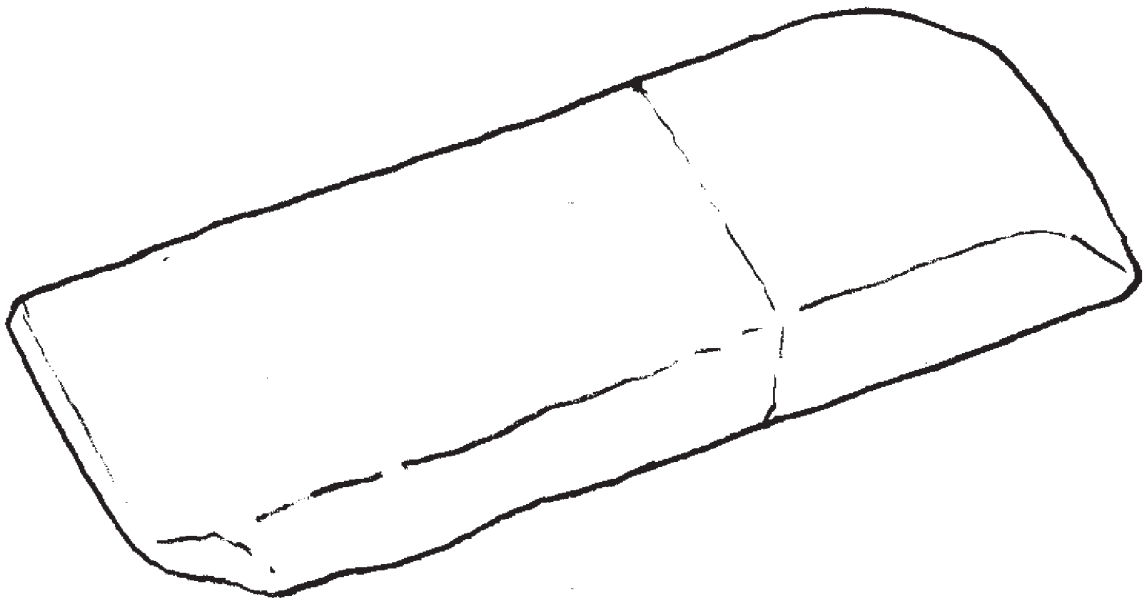

la gomme

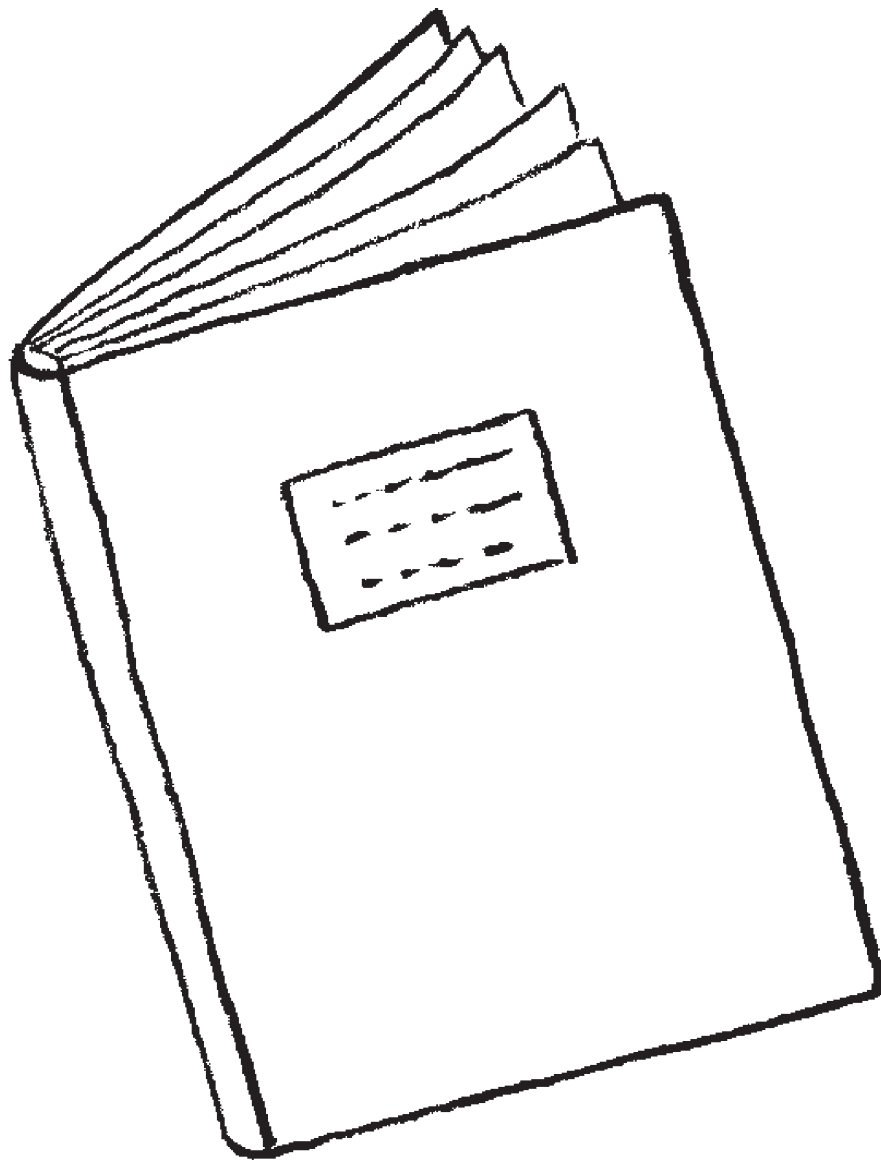

le cahier

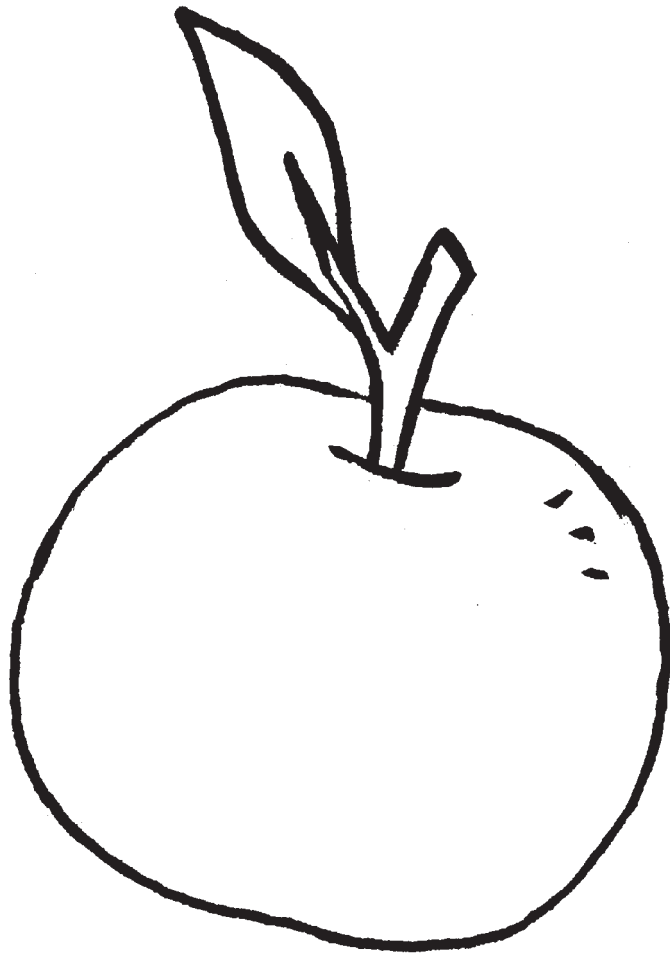

la pomme

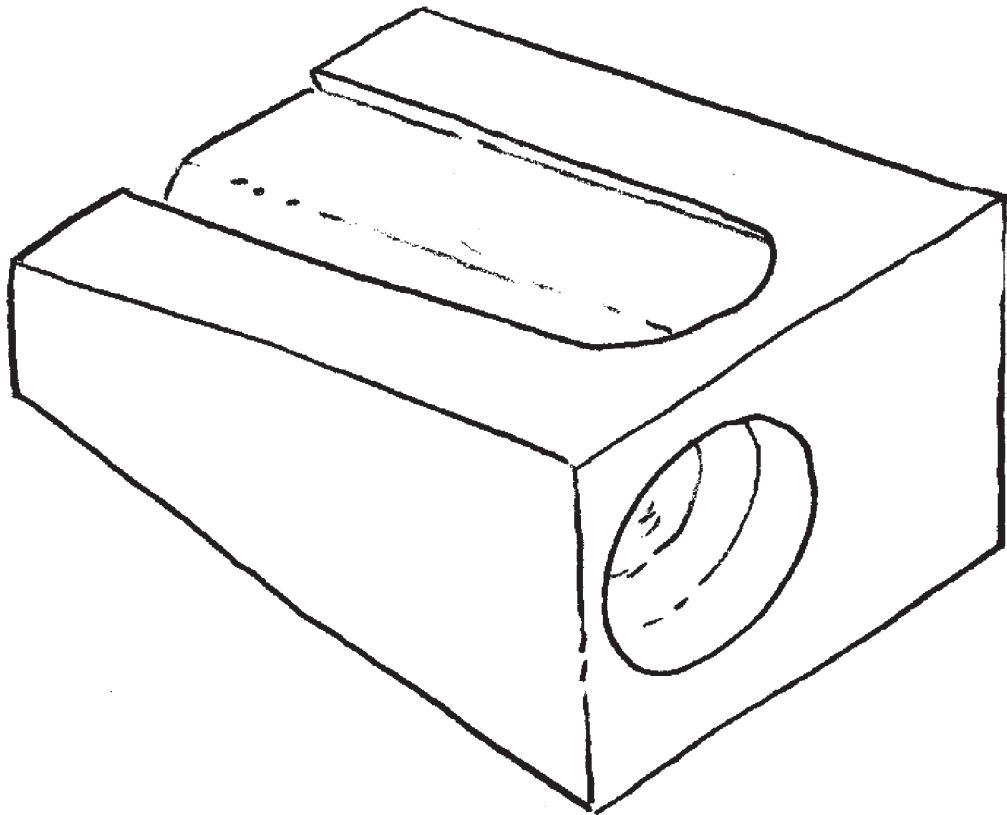

le taille-crayon

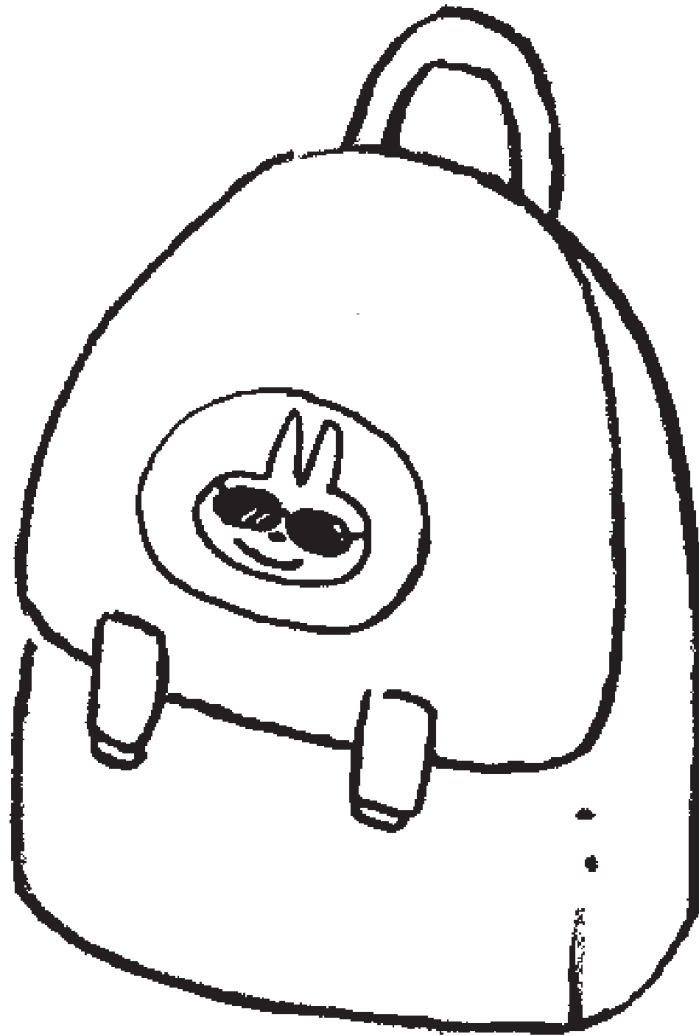

le cartable

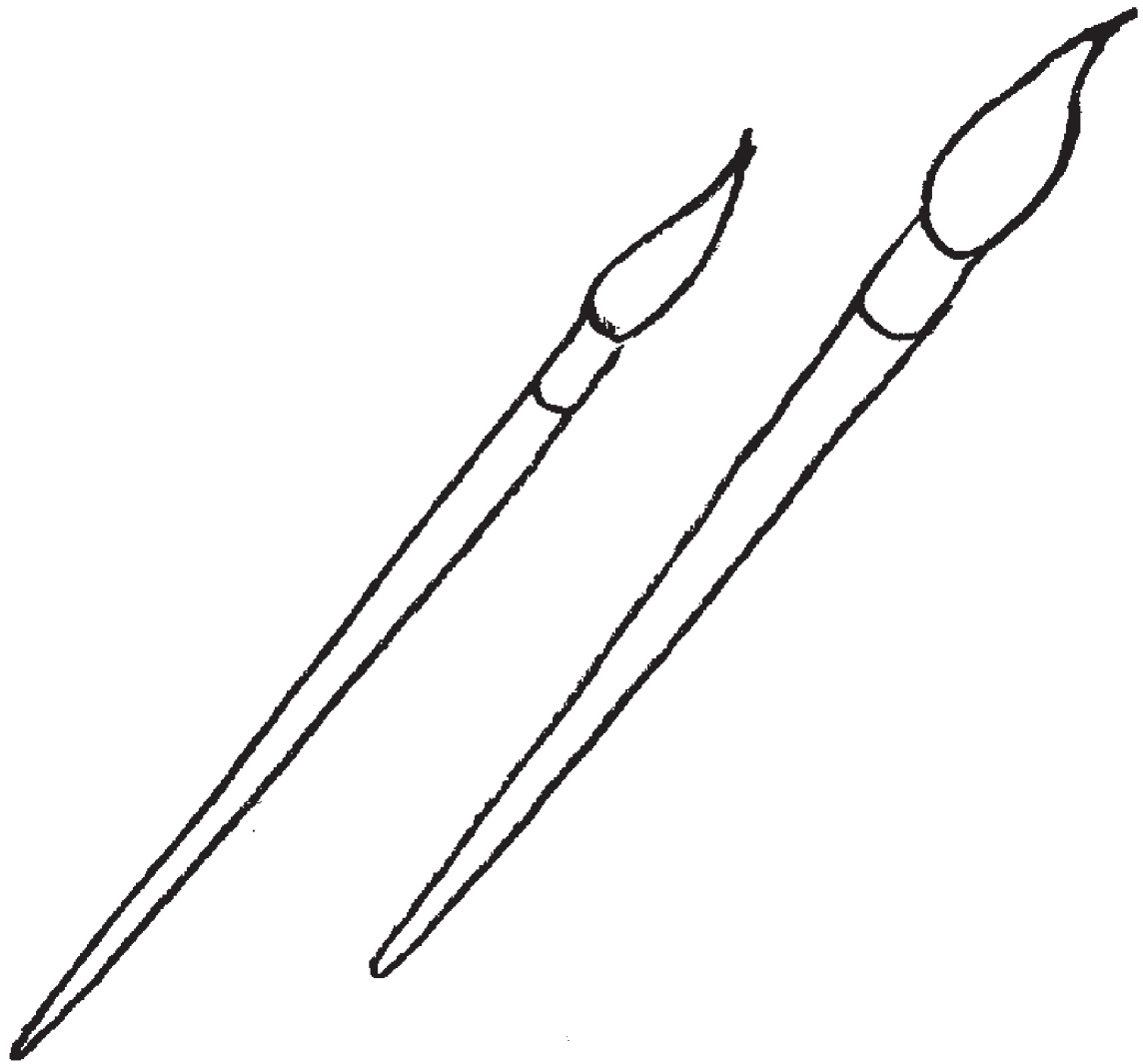

les pinceaux

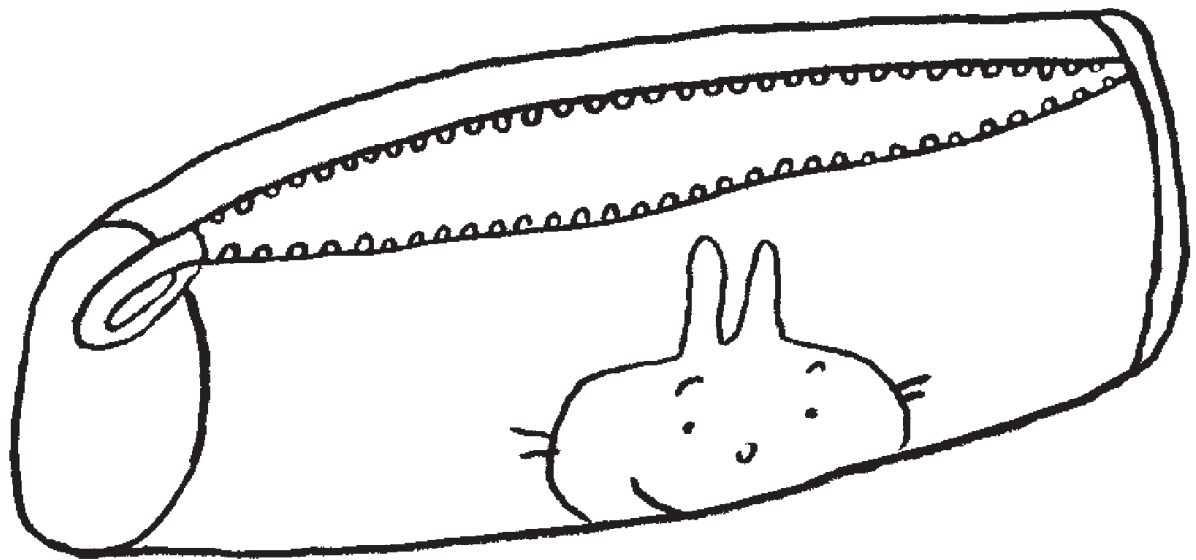

le plumier

$$1 + 2 = 3$$

le calcul

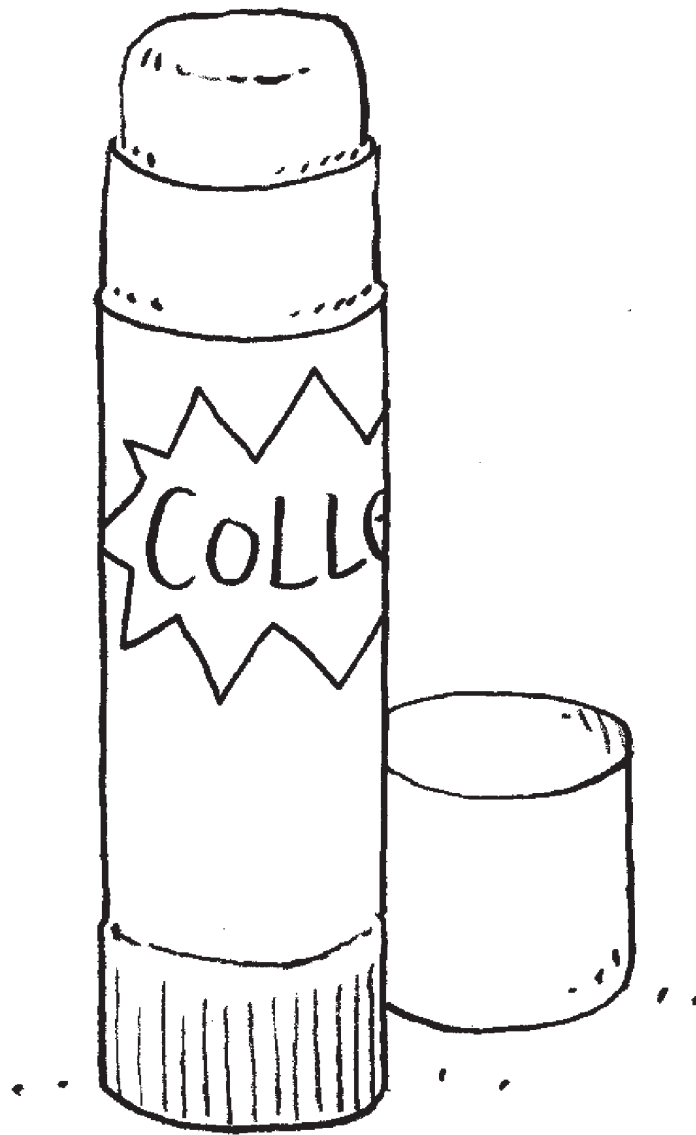

la colle

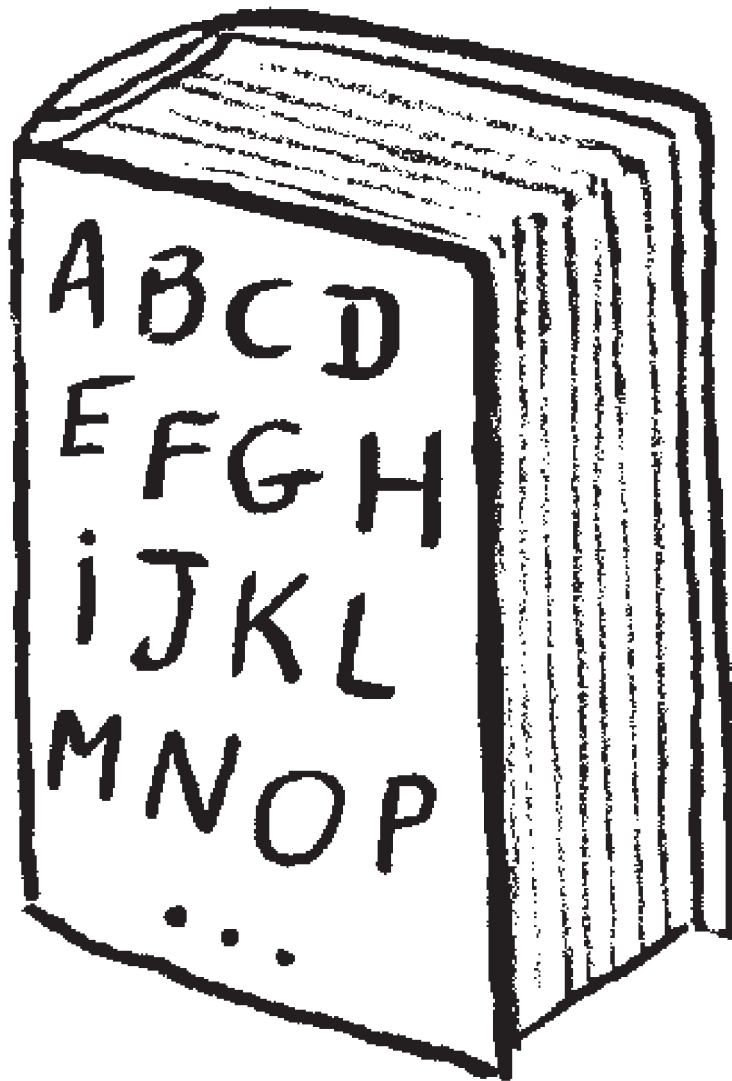

le dictionnaire



le rectangle

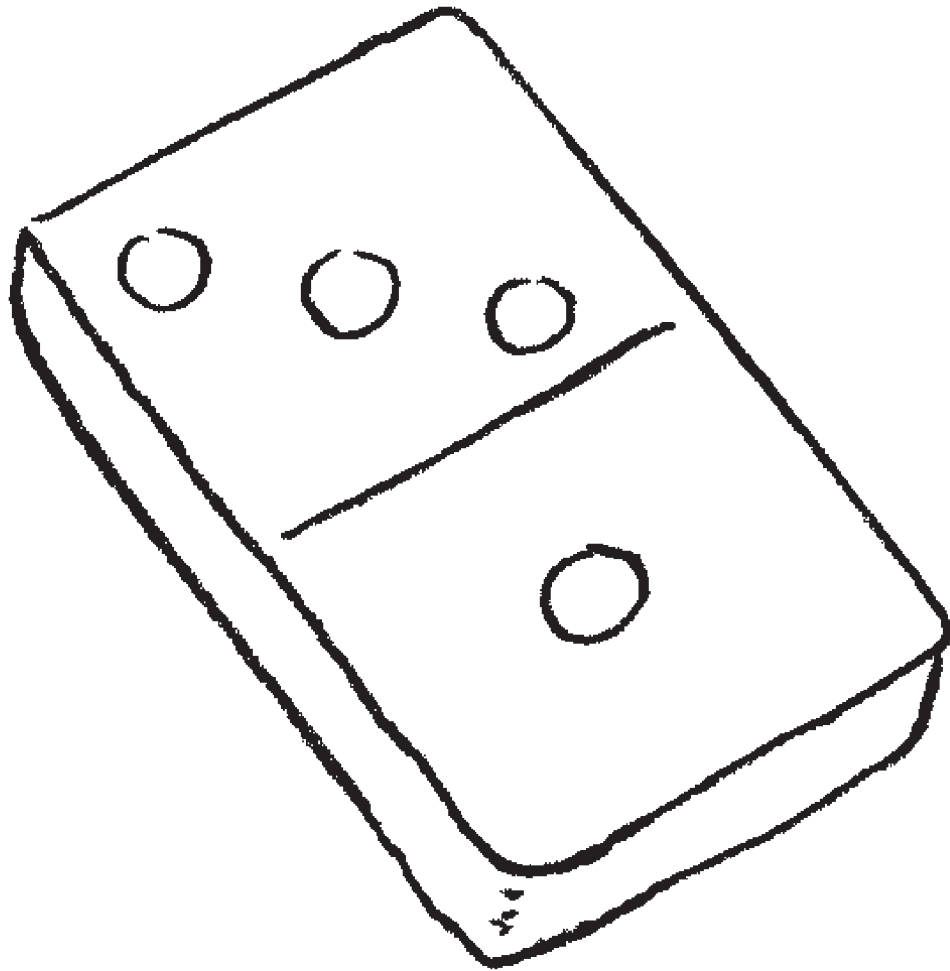

le domino

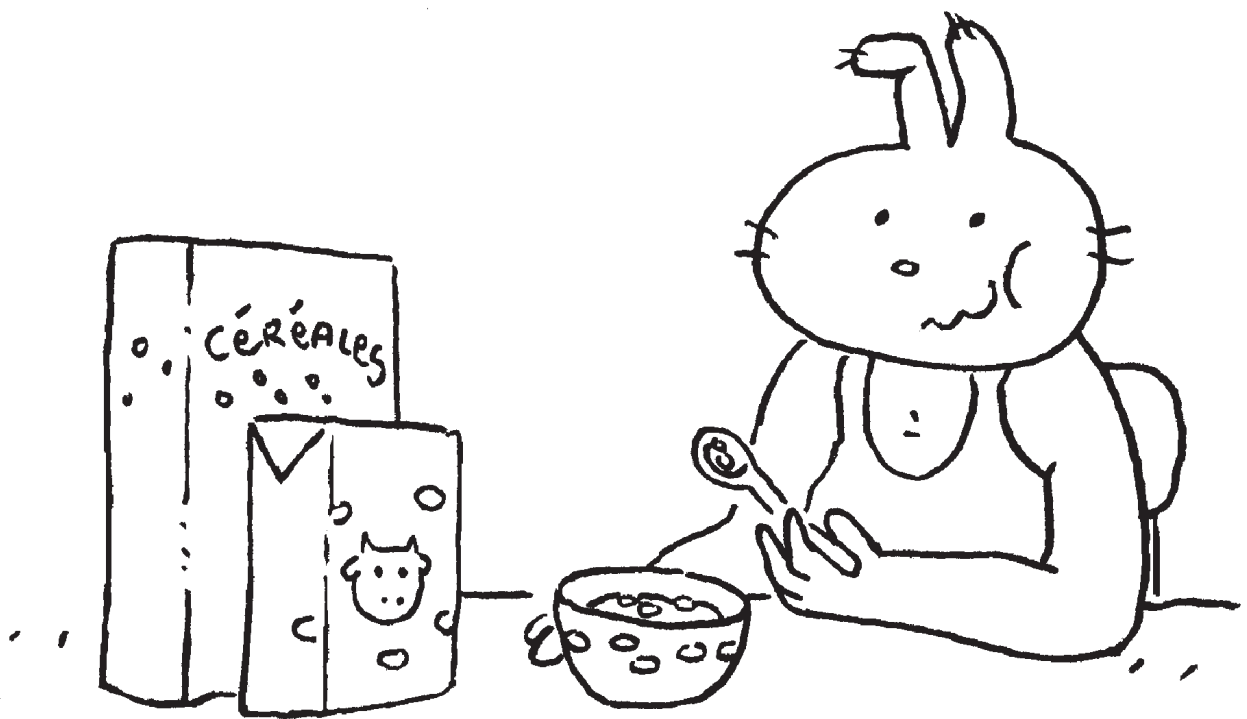

déjeuner



partir à l'école



se laver

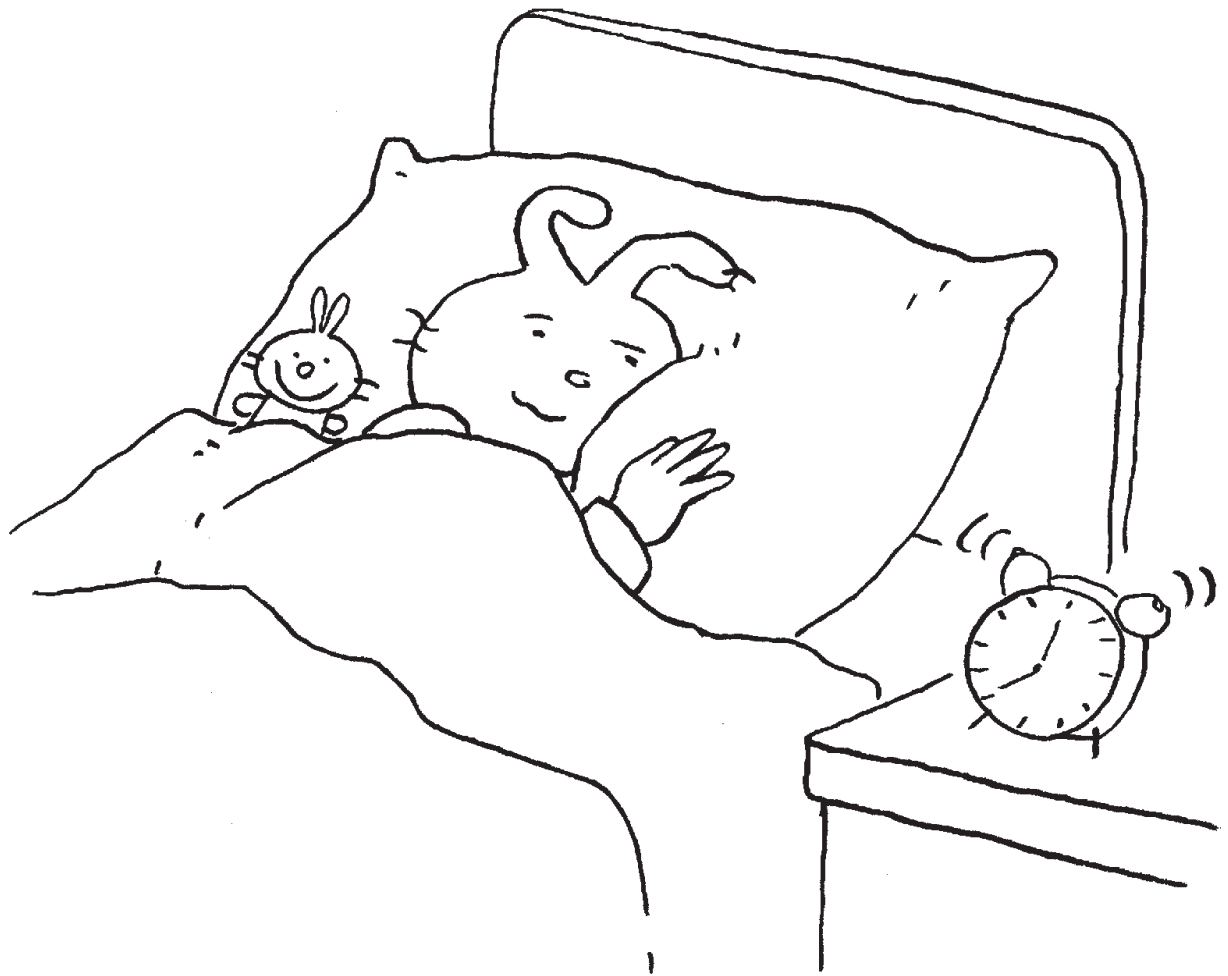

se réveiller



A midi, Polo mange

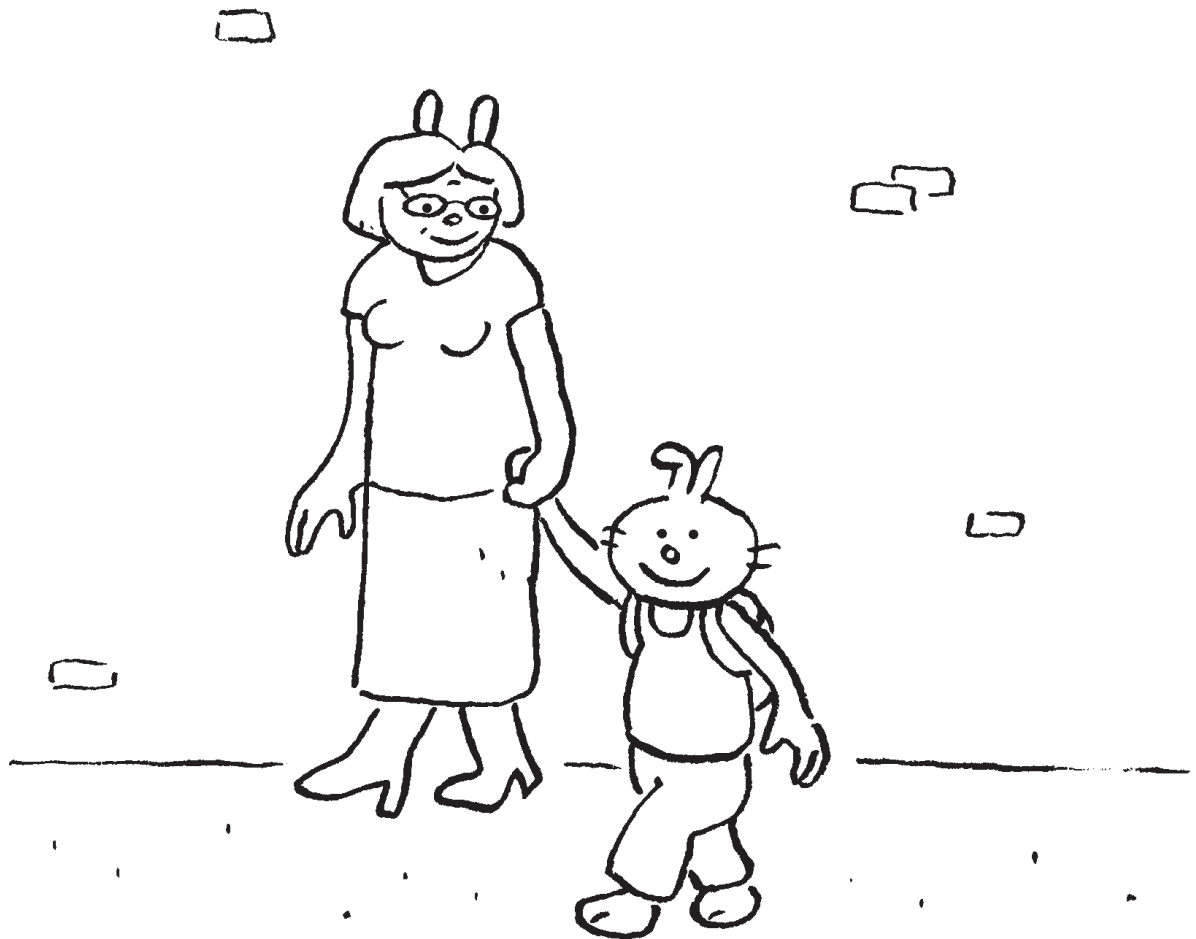

Polo rentre à la maison avec sa mamy

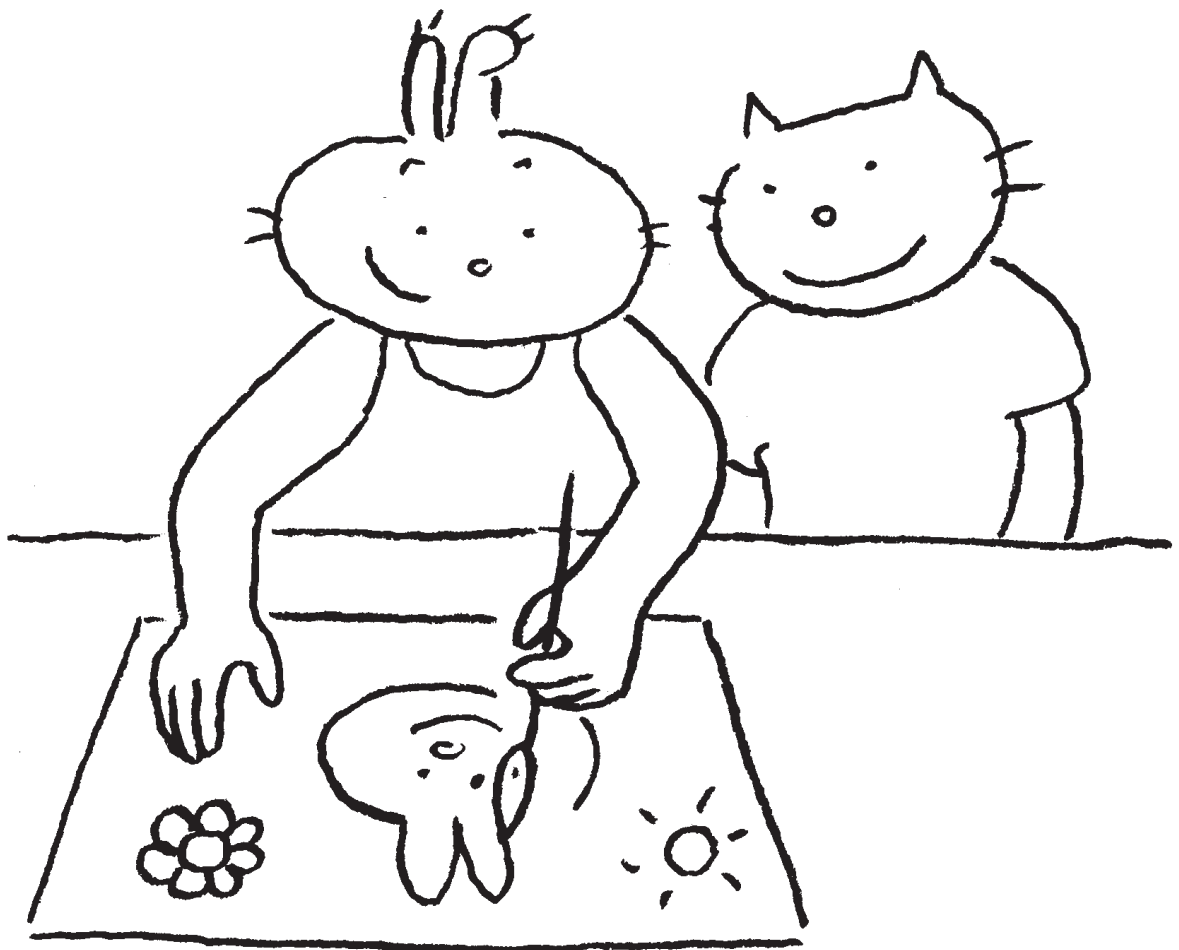

Polo travaille

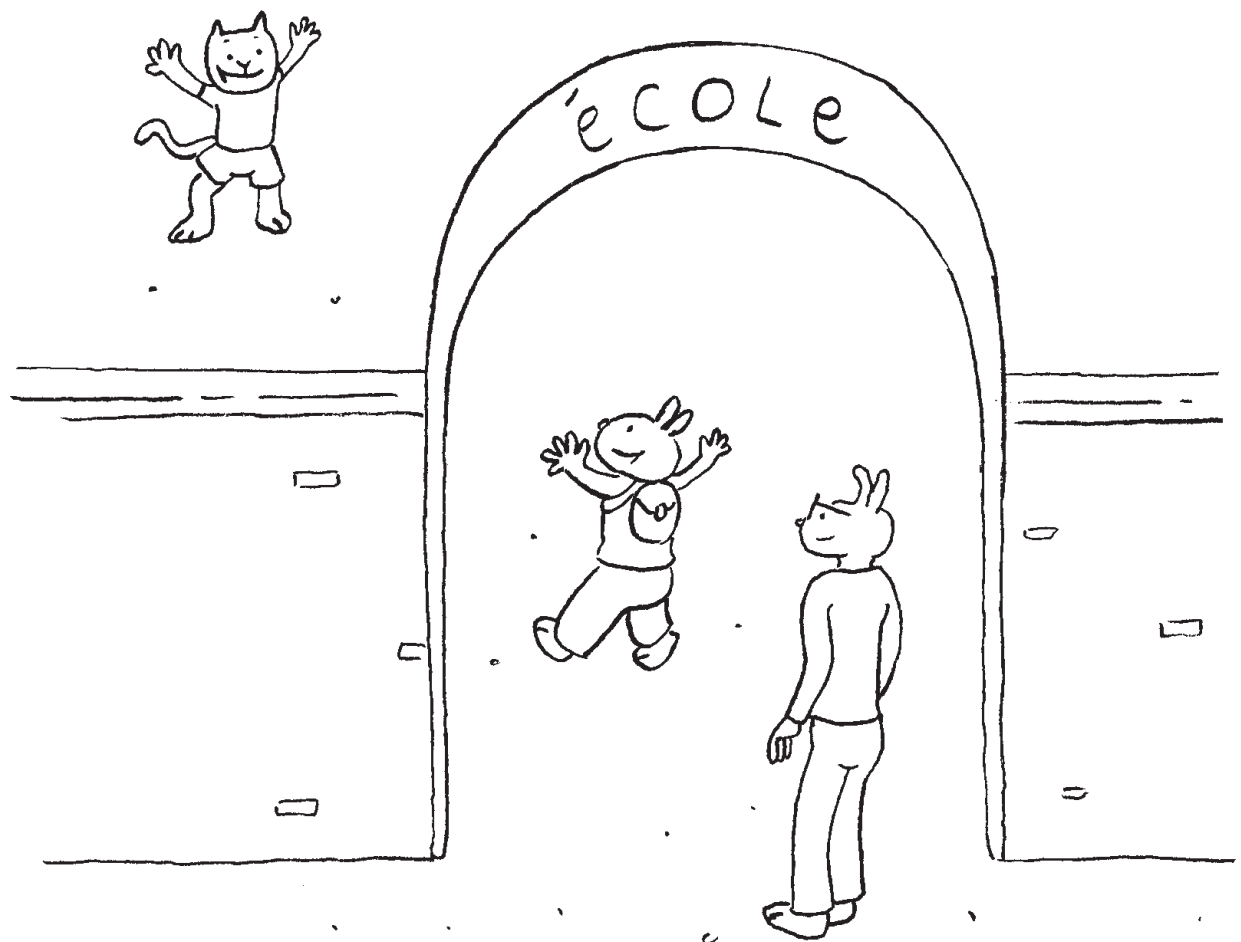

L'école commence

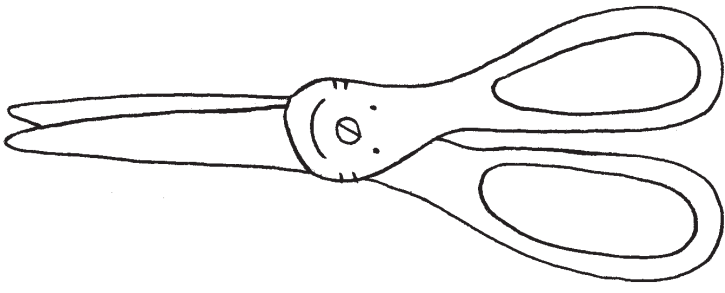

les ciseaux

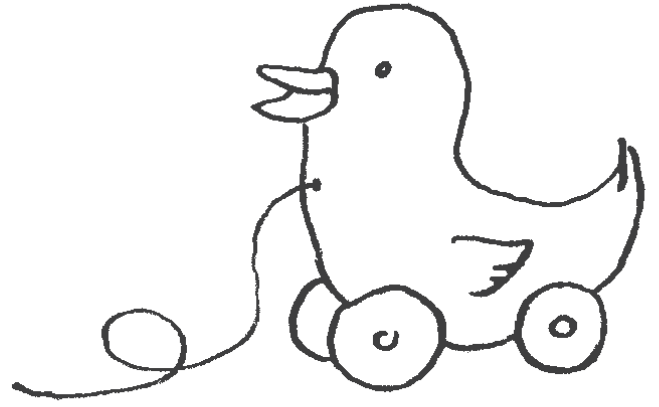

un jouet

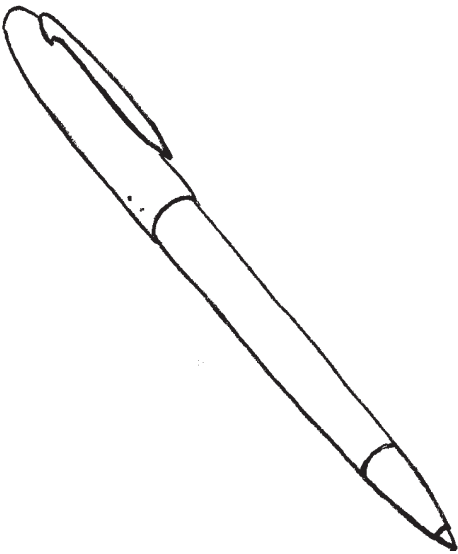

le stylo

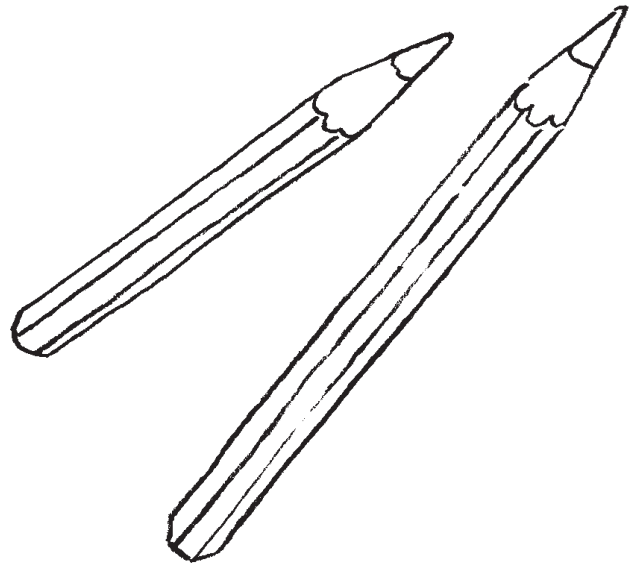

les crayons



un livre

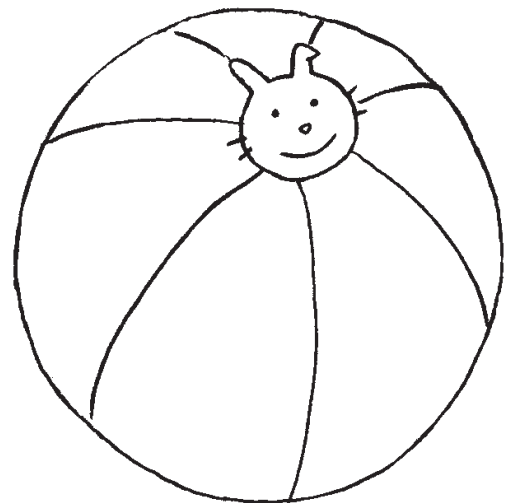

le ballon

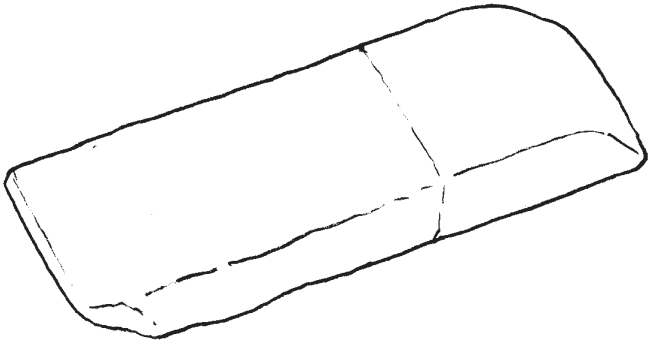

une gomme

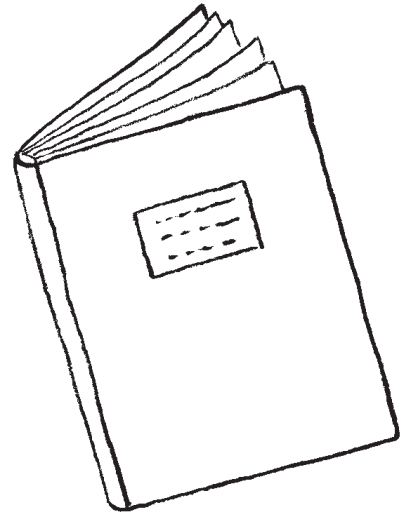

le cahier

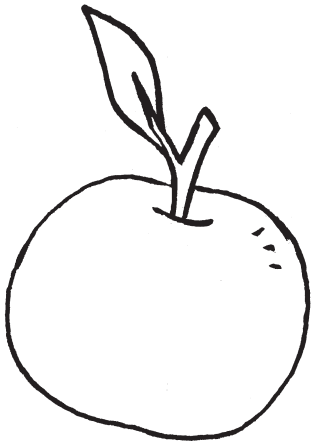

la pomme

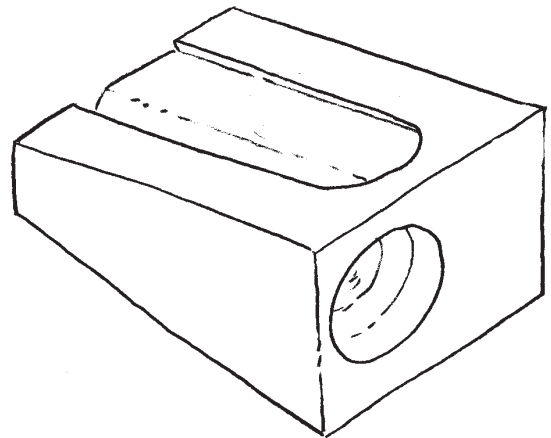

un taille-crayon

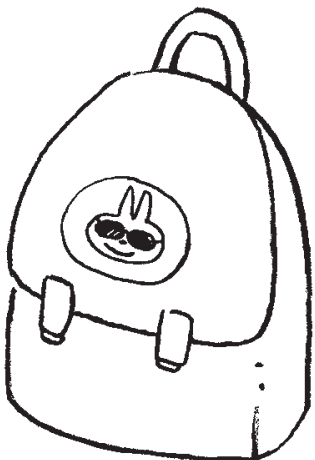

un cartable

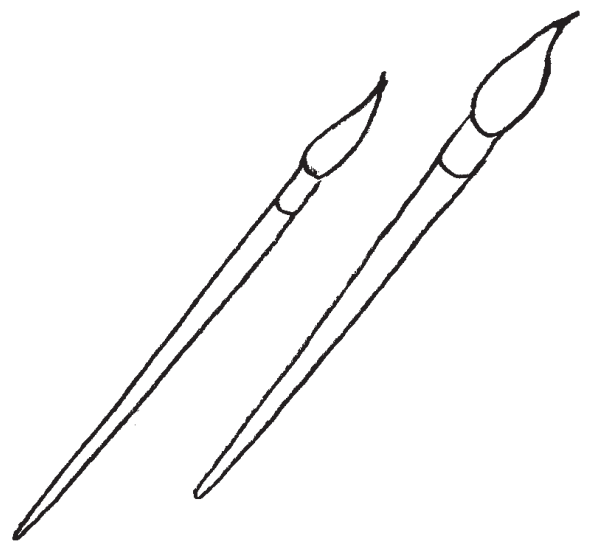

Les pinceaux

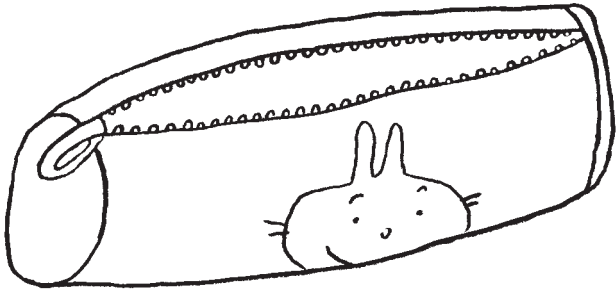

un plumier

$$1 + 2 = 3$$

le calcul

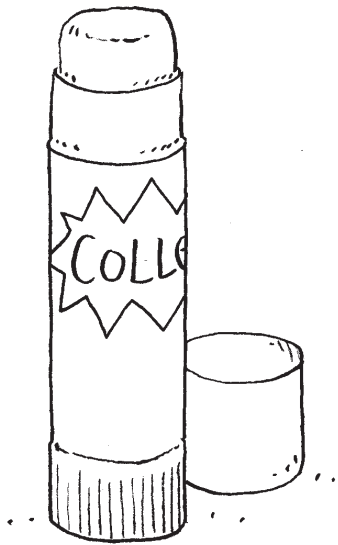

un tube de colle

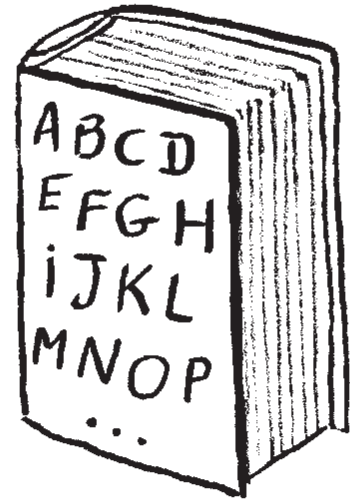

le dictionnaire



le rectangle

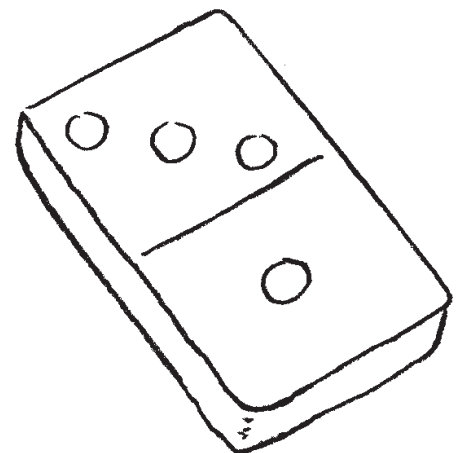

un domino